

Manual Inspectioncamera **US**

Wöhler VIS 500



Order no. 24994 2023-11-15

The measure of Technology

Contents

1	General information.....	5
1.1	Operation Manual Information.....	5
1.2	Copyright.....	5
1.3	Notes.....	5
1.4	Proper use.....	5
1.5	Scope of supply.....	6
1.6	Storage and transport.....	6
1.7	Information on disposal.....	7
1.8	Manufacturer.....	7
2	Important information	8
3	Technical data	10
3.1	Monitor.....	10
3.2	Wöhler pan & tilt camera head (optional)...	11
3.3	Mini camera head (optional).....	12
3.4	Camera Rod.....	12
3.5	Electronic meter counter.....	13
3.6	Storage.....	13
3.7	Twinwall hard case.....	13
3.8	Recording.....	13
4	Design and function	14
4.1	Video Inspection System.....	14
4.2	Monitor.....	16
5	Starting to use your camera system.	18
5.1	Activating the battery.....	18
5.2	Attaching the camera head.....	18
5.3	Using the monitor.....	19
5.4	Charging the rechargeable battery.....	20
6	Keys and their functions	22
6.1	On/Off key.....	22
6.2	Video key.....	23
6.3	Image key.....	24
6.4	Control pad.....	24

7	Display elements when menu is displayed	25
8	Displayed position of the camera head	26
9	Home function.....	26
10	Digital meter counter.....	26
11	Live menu	27
11.1	Brightness menu.....	27
11.2	Reset digital meter counter.....	27
11.3	Image and video gallery.....	28
11.4	System menu.....	31
11.4.1	Activate WLAN.....	31
11.4.2	Locator.....	32
11.4.3	Activate the locator detection.....	32
11.4.4	Settings.....	33
12	Transmission of images via WLAN ..	36
12.1	Hotspot: VIS 500 WLAN network.....	37
12.1.1	Change password and networkname	38
12.1.2	Select WLAN channel if necessary.....	40
12.1.3	Establishing a connection to a mobile device	41
12.2	WLAN: Using an existing WLAN network	42
13	Faults	44
13.1	Reset	44
13.2	Possible malfunctions	44
14	Maintenance	45
14.1	Information on maintenance	45
14.2	Replacing the dome of the camera head	45
14.3	Camera head	45
14.4	Monitor.....	45
14.5	Cleaning the viper and the rod.....	46
15	Guide accessories	51
16	Warranty and Service	52

16.1	Warranty.....	52
16.2	Service	52
17	Declaration of Conformity.....	53
18	Short Manual	55
18.1	On/Off - Key Menu-Key.....	55
18.2	Hidden menu.....	55
18.3	Menu on screen	55

1 General information

- 1.1 Operation Manual Information** This operation manual allows you to work safely with the Wohler VIS 500. Please keep this manual for your information.

The Wohler VIS 500 should be employed by professionals for its intended use only.

Liability is void for any damages caused by not following this manual.

- 1.2 Copyright** Without previous authorization of Wohler it is not allowed to reproduce, copy or translate this manual or part of this manual.

1.3 Notes



WARNING!

Not following this warning can cause injury or death.



CAUTION!

Highlights risks that can lead to damage occurring to the device.



NOTE!

Highlights tips and other useful information.

1.4 Proper use

The Camera is designed to visually inspect and document the condition of pipes and shafts, for example in flue gas systems, ventilation systems as well as for inspecting underground pipes etc.

The Camera is designed to be used by trained specialists only.

Any other use is considered improper use.

1.5 Scope of supply

Device	Scope of supply
Wohler VIS 500 Service Camera	Monitor
	Ø 1 ½ " pan and tilt color camera head, pluggable (option)
	Ø 1" miniature camera head, pluggable (option)
	Viper with 100 ft camera rod (65 ft. camera rod optional) and monitor cable 7 ft.
	1 USB power supply with USB-C-cable
	Twinwall hard case

1.6 Storage and transport

To avoid damage occurring during transport it is imperative that the complete system is transported in the original case.

1.7 Information on disposal



Electronic equipment does not belong into domestic waste, but must be disposed in accordance with the applicable statutory provisions.

You may hand in any defective batteries taken out of the unit to our company as well as to recycling places of public disposal systems or to selling points of new batteries or storage batteries.



1.8 Manufacturer

Wöhler Technik GmbH

Wöhler-Platz 1

33181 Bad Wünnenberg

Tel.: +49 2953 73-100

Fax: +49 2953 73-96100

Email: info@woehler.de

www.woehler.com

2 Important information

Body Protection



WARNING!

Never point a connected camera head at your own or somebody else's eyes when the monitor is switched on. The LEDs are extremely bright and can dazzle.



WARNING!

Guide the rod with due care and attention. As the rod is made of flexible material, it can make whipping movements if it slips. Protect your eyes in particular.



WARNING!

In order to limit the exposure of persons to electromagnetic fields, a safety distance of 5 cm must be maintained when the locating transmitter is switched on and when the user is temporarily or permanently near the camera head.

Working environment



WARNING!

Only place the camera on firm level ground and ensure a secure position of camera and user, especially when working in high altitude, e.g. when working on the roof.



WARNING!

Make sure that the parts that you are going to inspect are no live parts.



CAUTION!

Protect the camera head against oil and acid. Never use the camera head and rod to push obstructions.

Operating Temperature



CAUTION!

Do not use the camera in temperatures above 40°C. High temperatures can damage the camera.

Resistance to water



CAUTION!

Only the camera head and the rod are waterproof. Keep the camera system dry and protect it from water!

Resistance to impacts



CAUTION!

The camera system is not impact resistant. Do not throw or allow the case to fall!

Accessories



CAUTION!

Use only original Wöhler accessories and spare parts!

Strong magnetic or electric fields



NOTE!

Do not use the camera near television towers, mobile radio equipment or other sources of magnetic or electric fields, as these may impair the quality of the displayed image.

Extraneous influences



NOTE!

Extraneous influences such as static discharges can cause the device to malfunction. If a malfunction occurs, switch the monitor off and on again.

3 Technical data

3.1 Monitor



Fig. 1: Monitor

Description	Data
Dimensions	0.8 x 0.5 x 0.2 ft
Screen diagonal	7 inch
Weight	710 g
TFT display	7" / 16:9 format 1024 x 600 pixel
Charging cable	USB-C 5 V/3 A
Power supply	3,7 V, 11400 mAh Li-Ion Akku
Operating time	6 h
Operating Temperature	32 - 104 °F
Storage Temperature	- 4° - 122°F
WLAN function	Wireless LAN IEEE 802.11 b/g/n network standard 2412-2462 MHz, < 10dBm

3.2 Wöhler pan & tilt camera head (optional)



Fig. 2: pan & tilt camera head

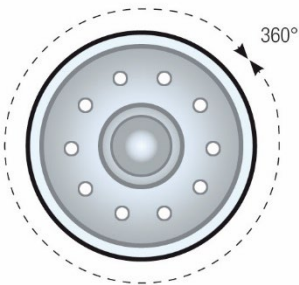

Fig. 3: Pans through 360°

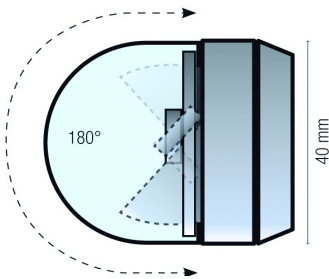

Fig. 4: Tilts 180°

Description	Data
Classification Type	1/4" Color CMOS
Resolution	720 x 576 px (PAL) 720 x 480 px (NTSC)
Lens	f = 0.10 ", F = 2,4
Light source	10 white LEDs
Protection	Waterproof to IP 67 (up to 1 m depth for 30 mins.)
Dimensions	Ø 1 ½ "
Frequency of the integrated emitter	9,2 kHz
Angle of detection	70°
Operation temperature	32 - 104 °F, RH 95 % max.
Storage temperature	- 4° - 122 °F RH 95 % max.

3.3 Mini camera head (optional)



Fig. 5: Mini Camera Head

Description	Data
Classification Type	1/4" Color CMOS
Resolution	720 x 576 px (PAL) 720 x 480 px (NTSC)
Lens	f = 0.10 ", F = 2.4
Light source	10 white LEDs
Protection	Waterproof to IP 68 (up to 1181" depth for 30 mins.)
Dimensions	1"
Frequency of the integrated emitter	9,2 kHz
Angle of detection	100 °
Operation temperature	32 - 104 °F, RH 95 % max.
Storage temperature	- 4° - 122 °F RH 95 % max.

3.4 Camera Rod

Description	Data
Length	1181 m or 787 m
Minimum bending radius	ca. 12"
Connection cable to the monitor	79"

3.5 Electronic meter counter

Description	Data
Resolution	0,9"
Max. deviation	5 % of reading

3.6 Storage

Description	Data
Memory	Internal memory or USB stick with 32 GB max. (we recommend the Wöhler art. 11269)
Max. recording time of the internal memory	1 h
Resolution of savings	
Image, with text overlays (.png)	1024 x 600 Pixel
Image, without text overlays (.png):	1024 x 685 Pixel
Video (.mkv):	720 x 576 px (PAL) 720 x 480 px (NTSC)

3.7 Twinwall hard case

Description	Data
Dimensions	7 x 18 x 20 "
Total weight with monitor, camera head and rod	10 kg

3.8 Recording

Description	Data
Max. Video recording duration (video will end automatically)	29 minutes and 59 seconds (29:59 min)

4 Design and function

4.1 Video Inspection System



Fig. 6: Wöhler VIS 500 Camera System

Legend:

- 1 Monitor
- 2 Short Manual
- 3 Space for accessories, charging cable, camera head etc.
- 4 Opening for the camera head and camera rod (rod outlet)
- 6 Lock of the camera case
- 7 Locks of the lower shell

4.2 Monitor

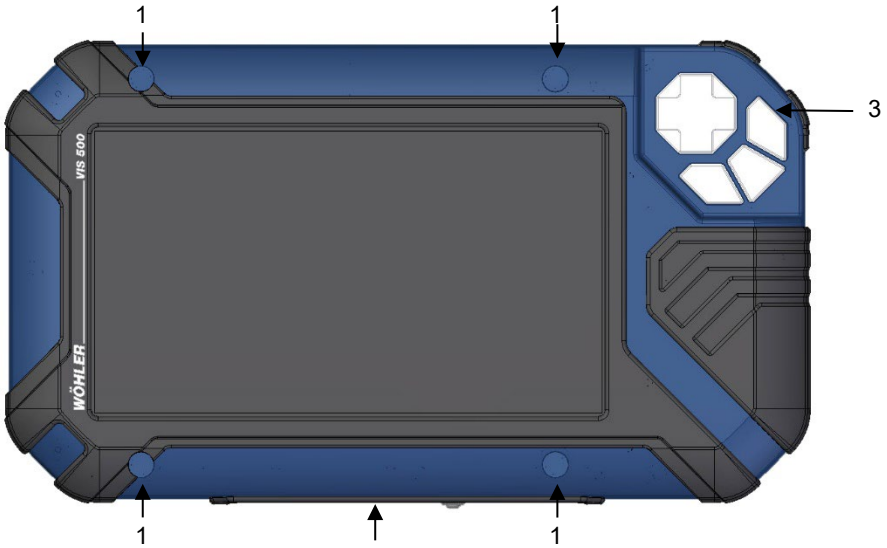

Fig. 7: Monitor

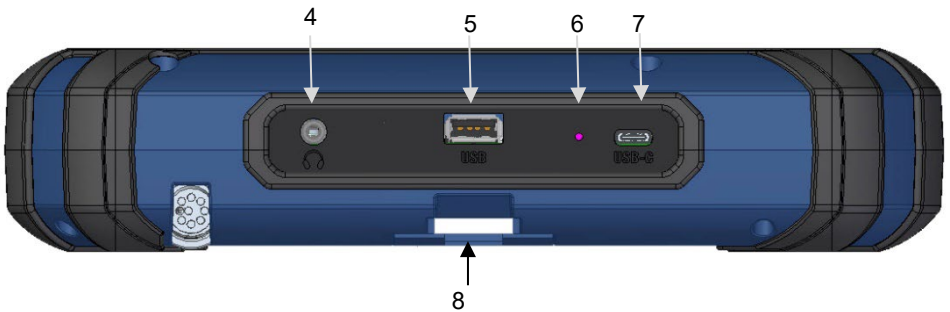

Fig. 8: Bottom side of the monitor with terminal strip

Legende:

- 1 Fixing holes for glare protection
- 2 Bottom side of the monitor with terminal strip
- 3 Operation panel
- 4 CTIA standard connection for headset with headphone and microphone to record a commentary during video recording
- 5 USB port for stick
- 6 Reset opening
- 7 USB port for charging cable
- 8 Notch for placing the monitor on the connecting rail of the case

5 Starting to use your camera system

5.1 Activating the battery

If the camera system cannot be switched on during initial operation, you have two options for activating the battery:

- Connect the monitor to the mains via the power supply unit. Switch on the camera system.

Afterwards, the camera can also be switched on without being connected to the power supply.

or

5.2 Attaching the camera head

- Carry out a reset 1, see chapter 13.1.
- Open the cover in front of the camera rod (Fig. 6, part 4)
- Carefully pull the rod out of the case.
- If it is not already connected to the rod, connect the camera head to the rod as follows: Insert the eight-pin connector of the camera rod into the socket of the camera head. Then screw together the threaded parts of the camera head and camera rod.



CAUTION!

The connection is only waterproof when the connectors are joined together properly.

5.3 Using the monitor

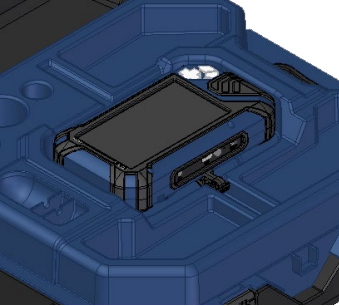

Fig. 9: Monitor lying in case shell

- To put the monitor upright, grasp it by the upper edge and tilt it up.
- To return the monitor to the transport position, fold it down.

! CAUTION!

If there is any resistance when pushing down the monitor, check the connection cable has been placed under the monitor properly rolled up.



Fig. 10: Tilt the monitor up and down

When released from the case you can tilt the monitor up and down and turn it around its longitudinal axis. Locking points ensure the camera is held in a stable position.



Fig. 11: Monitor removed from the case

It is also possible to take the monitor from the case and hold it in your hands.

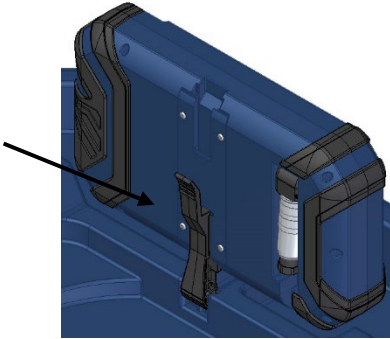

Fig. 12: Press the lever to release the monitor from the holder

Screen Protector

Proceed as follows to release the monitor from the holder:

- Put the monitor in an upright position.
- Press against the lever on the rear of the monitor.
- At the same time pull the monitor out of the holder.

The transparent screen protector can be removed and refitted depending on how the camera is used.

- Insert both pins of the Screen Protector into the corresponding fixing holes above or below the display to suit your working position. Magnets at the ends of the pins ensure a stable hold.

5.4 Charging the rechargeable battery



WARNING!

Danger of death by electrocution!

Never touch a mains plug with wet hands!

Do not expose the power pack to moisture!

Never pull the cable to remove the power pack from the socket outlet - it could rip out the cable!

Operate the power pack only when the mains power supply is the same as the voltage stated on the rating plate!



Fig. 13: Battery charge icon 60%

A battery charge icon is on the right of the icon ribbon. The charge level is displayed in either blue or orange ($\leq 20\%$).

- Recharge the rechargeable battery if the charge level is displayed in red ($\leq 10\%$).

When the battery is low, the buttons flash red when you try to switch on the camera. In this case,



Fig. 14: USB port indicated by an arrow

the camera can only be switched on when it is connected to the mains.

- To charge the battery, connect the monitor to the mains using the USB power pack included in the scope of supply.
- To do so, insert the USB C connector into the USB port on the bottom of the monitor.

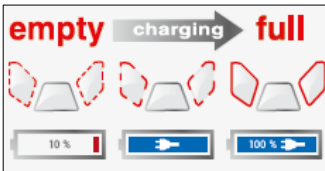

Fig. 15: Keys and charge level indicated when charging

When the camera system is switched off the image and video keys flash red during the charging process.

The image and video keys light up red when the battery is fully charged.

The camera system remains fully functional during the battery charging process.



NOTE!

If possible, recharge the battery when the camera system is switched off. This increases the operational lifetime of the rechargeable battery.

The keys will not flash if the battery is recharged with the camera system switched on. In this case a connector symbol is displayed in the rechargeable battery display.

6 Keys and their functions

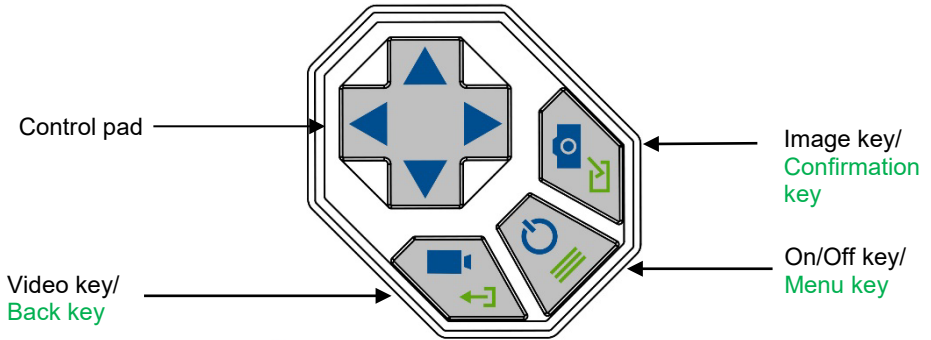

Fig. 16: Monitor keys

6.1 On/Off key

Switching on the system

- When the system is switched off, press and hold the ON/Off key for approx. 1 second. The ON/Off key then lights up green.

After approx. five seconds the LEDs light up on the camera. The Home screen is displayed followed by the camera image.



NOTE!

It is possible to rotate the monitor 180°. The icon and information ribbons in the monitor are automatically aligned according to the monitor position. After switching on, the lower edge of the display is always flush with the control pad.

Switching the system off

- Press and hold the On/Off key for approx. two seconds until the system switches off.

Calling up the menu

- When the system is switched on briefly press the **menu key** to display the menu.
- Briefly press the **menu key** again to hide the menu.

6.2 Video key



NOTE!

Before starting to record a video make sure the menu is not displayed. Otherwise it is not possible.

- To start recording a video, briefly press the video key.
- To stop recording the video, briefly press the video key again.

A red dot and the video recording time are displayed in the information ribbon of the display when a video is being recorded



NOTE!

If no USB stick is inserted, the video is saved in the camera's internal storage.

If a USB stick is inserted, the video is saved on the USB stick.



NOTE!

In any case, use a short USB stick, as a long USB stick could break off in the case. We recommend the Wöhler article 11269.



NOTE!

It is not possible to save the position indicator when recording a video.

If you require this information, it is recommended that you capture an image while recording the video. In the photo all information is shown as graphical elements.

Record time



NOTE!

After 30 minutes the camera will automatically stop recording a video. If the video has to be recorded over a longer period of time, the user has to start recording again by pressing the video key after 30 minutes.



NOTE!

The minimum record time is 10 seconds. Even if the user tries to stop the record before, the camera will stop recording after 10 s only.

6.3 Image key



NOTE!

The camera will only capture an image when the menu is not displayed.

- Press the image key briefly to capture a photo. It is possible to capture an image while recording a video.



NOTE!

The image contains all the information that is shown in the camera display (comments etc.). In the settings menu you can set the photo to be saved without this information, see chapter Settings11.4.4.



NOTE!

If no USB stick is inserted, the image is saved in the camera's internal storage.

If a USB stick is inserted, the image is saved on the USB stick.

6.4 Control pad

When the menu is not displayed, use the control pad to control the camera head

When the menu is displayed, the control pad is used for the menu navigation.

Pan 180°

- Pan the camera head with the up/down arrows.

Rotate 360°

- Rotate the camera head with the left/right arrows.

7 Display elements when menu is displayed

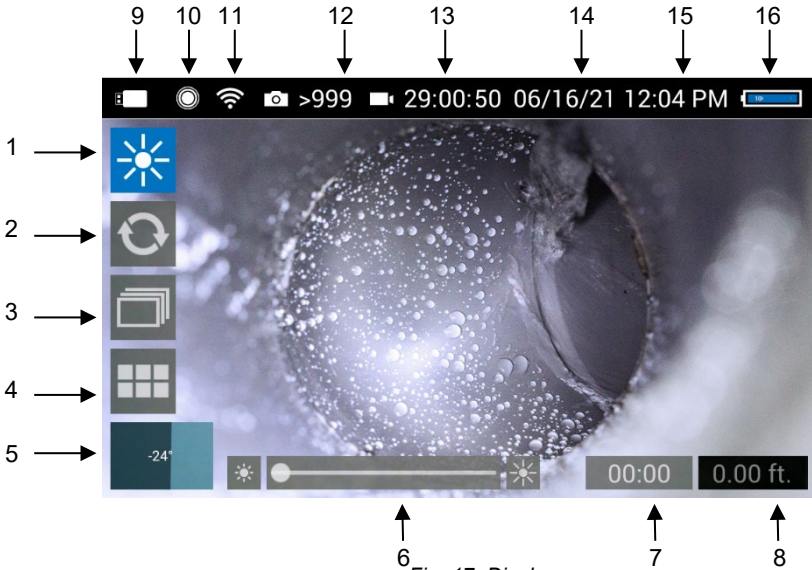

Fig. 17: Display

Legend:

- 1 Brightness control
- 2 Reset meter counter
- 3 Image and video gallery
- 4 System menu
- 5 "Horizon" with tilt and pan angle display / Home function
- 6 "Brightness" slider (the "Focus" slider can also be displayed here)
- 7 Video recording time
- 8 Meter counter
- 9 USB Stick inserted
- 10 Locator active
- 11 WLAN active
- 12 Number of possible images remaining
- 13 Remaining video recording time
- 14 Date
- 15 Time
- 16 Remaining battery charge

8 Displayed position of the camera head

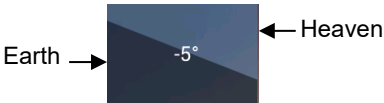

Fig. 18: Horizon icon including degree display

9 Home function

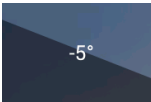

Fig. 19: Tap the horizon icon to level the camera head

10 Digital meter counter



Fig. 20: Reset icon (meter counter)

The horizon icon indicates the downward gradient of the pipe.

Example:

- 5° corresponds to a downward gradient of 5°

(+ 5° corresponds to an upward gradient of 5°)

The Home function makes it possible to align the camera head in a straight position, so that the camera faces “straight ahead” and the tilt and pan angle display is depicted parallel to the ground below.

- To activate the Home function tap the horizon symbol in the display.
- Go to the horizon icon with the control pad and confirm with the **confirmation key** or the right arrow.

The meter counter display information tells you how far the camera head has been pulled out of the case. To precisely determine the position of the camera head in the pipe, proceed as follows:

- Insert the camera head into the beginning of the pipe.
- Switch on the menu to display the reset icon, see chapter 11.
- Go to the reset icon with the control pad and confirm with the **confirmation key** or the right arrow.

The position indicator is now set to 0.

11 Live menu



Fig. 21: Menu bar

Via the live menu, settings can be made on the camera system.

- To display the menu, briefly tap the **Menu key** when the system is switched on.

The following icons appear:

Brightness control, Reset meter counter, Image and video gallery, System menu.

- To hide the menu, briefly tap the **Menu key** again.
- When the menu is displayed, use the control pad to navigate through the menu items. Confirm your selection with the **confirmation key** or the right arrow. Exit the submenu with the **back key** or the left arrow.

11.1 Brightness menu



Fig. 22: Brightness menu icon

In the Brightness menu it is possible to regulate the light intensity of the camera head LEDs. In the lowest level, the LEDs are completely switched off.



NOTE!

You can change the display brightness in the system menu, see chapter 11.4.4.



Fig. 23: Brightness bar

- Go to the Brightness menu icon.

A sliding bar appears at the bottom of the display.

- Decrease or increase the brightness of the LEDs with the right/left arrows.
- Exit the brightness menu with the up/down arrows.

11.2 Reset digital meter counter

See Chapter 10, Digital meter counter .

11.3 Image and video gallery



Fig. 24: Image and video gallery icon

- Use the up/down arrows to go to the gallery icon and confirm with the **confirmation key** or the right arrow.
- Leave the image and video gallery with the **back key** or the left arrow.

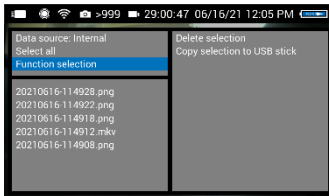

Fig. 25: Image and video gallery

The Picture and Video Gallery displays all the pictures and videos you have taken, depending on the selection from the internal storage or from the USB stick.

The respective file name consists of the date and time of the recording.

You have the option of viewing or deleting image and video files or copying them from the internal storage to the USB stick.

Select image and video files

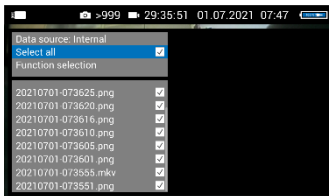

Fig. 26: All image and video files selected

- To select one or more image and video files use the up/down arrows and confirm with the **confirmation key**.
- Use the **confirmation key** to deactivate the selection again.
- To select all files tap on “Select all” and confirm with the **confirmation key** or the right arrow.

View images and videos

- Use the up/down arrows to select the file to be displayed.
- Confirm the selection with the right arrow to display full screen.
- Confirm again to play the video.



NOTE!

While the camera is playing the video you have the option to stop the video with the **confirmation key** and start it again. If you use the left/right arrow you can go 10 s fast forward or rewind. The

icons are displayed in the upper left corner of the display.

- Go back to gallery with the **back key** or left arrow.
- Select the files to be deleted.
- With the up/down arrows go to “Function selection”
- With the right arrow go to “Delete selection” and confirm.

Delete images and videos

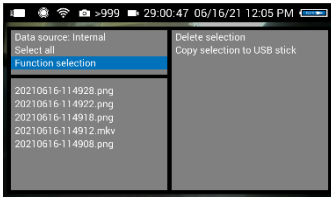

Fig. 27: Delete selected files



NOTE!

Never remove the USB stick immediately after deleting or copying files to it. In this case, there is a risk of data loss.

Always leave the gallery before removing the stick.

Save images and videos

- Images and videos are automatically saved to the internal storage if no USB stick is connected to the monitor.
- If a USB stick is connected to the monitor, images and videos are automatically saved on the USB stick.

Copy files to USB drive

- Connect the USB stick to the monitor.
- Select **Data source: Intern**
- Highlight the files as described before
- Select **Function selection > Copy selection to USB stick** and confirm with the **Confirmation key** or the right arrow.

How to see videos on a PC



NOTE!

During video playback, the date, time and meter count are always displayed in the video, regardless of which media player is used.

You can playback a video on the PC using the Windows Media Player or VLC Player once you have saved the respective video file to the PC. If you work with a Windows PC, the Media Player will already be installed on the PC. The VLC Player is available to download free of charge from the website www.videolan.org.



NOTE!

Depending on the size of the video file it can take several seconds for the video to load before it is ready to play.

11.4 System menu

- Select the system menu.



Fig. 28: System menu selected



Fig. 29: System menu with WLAN (1), Locator (2), settings (3) and Info menu (4)

The System menu has the following submenus:
WLAN, Locator, Settings, Info menu.

The active submenus are highlighted blue, inactive submenus are grey.

11.4.1 Activate WLAN

This function is described in the following chapter 12.



Fig. 30: WLAN icon

11.4.2 Locator



Fig. 31: Locator icon

11.4.3 Activate the locator detection



Fig. 32: Locator detection with 8.9 kHz transmission frequency selected

In the submenu “Locator” you can activate and deactivate the „Locator transmitter“ inside the camera head. It is possible to select a transmission frequency.

- Select the transmission frequency with the **confirmation key** or the right arrow (a hook appears next to the selected frequency).



NOTE!

In the USA, the transmission is only allowed at 8.9 kHz.

- To deactivate the locator transmitter remove the hook next to the frequency by pressing the **Confirmation key** again.

If the locator transmitter is active it is possible to detect the camera head with the Wöhler Locator L 200.



NOTE!

If you do not want to locate the camera head, switch off the locator transmitter to save power.

The locator transmitter is always switched off when turning on the camera system.

11.4.4 Settings

Display backlight

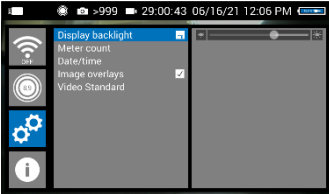

Fig. 33: Slide bar: display backlight

Here the display backlight can be adjusted. (To adjust the illumination of the camera head, see chapter 11.1.

When the camera is turned on, the display brightness is always set to 70%.

It is possible to adjust the display brightness in 10 levels from 10% to 100%.

- Change the display backlight with the left/right arrow.
- If you want to retain the setting of the display brightness even after switching on again, tap the **confirmation key**.

The memory icon reacts briefly.



NOTE!

To reduce power consumption when the battery is low, it is advisable to choose a low backlight.

Meter Count Unit

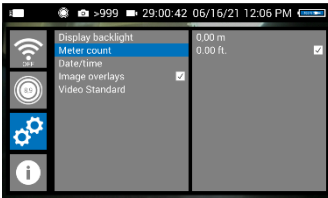

Fig. 34: Selection of unit of the counted meters

The counted meters can be displayed in 2 units:
 0.00 m (Meter)
 0.00 ft. (feet)

- Activate the requested unit with the **Confirmation key** or the right arrow.

Date/Time

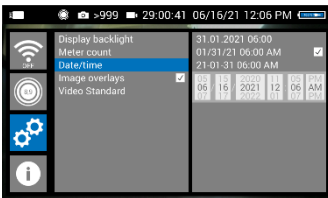

Fig. 35: Submenu „Date and Time“

Here you can change the type of display of date and time. **The following possibilities exist:**

GERMAN:

Day.Month.Year
 00.00 – 24.00

USA:

Month/Day/Year
 00:00 – 12:00 AM and 00:00 – 12:00 PM

INTERNATIONAL:

Year-Month-Day
 00:00 – 12:00 AM and 00:00 – 12:00 PM



Fig. 36: Setting of Date and Time

- Go to the date and time setting with the up/down arrows.
- Select the field to be adjust with left/right arrows.
- Make the setting with up/down arrows.
- Confirm the setting with the **Confirmation key**.

Image overlays

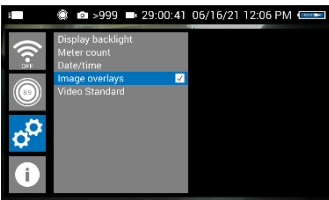

Fig. 37: Additional information are saved with the image

Video standard

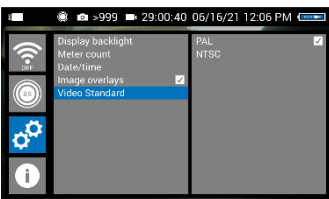

Fig. 38: Selection of video standard

System Update



Abb. 39: System-Update

The photos taken with the Wöhler VIS 500 contain all the information shown in the camera display (comments, meter count etc.)

- Activate or deactivate the settings with the **Confirmation key** or the right arrow.

The settings are saved automatically and are retained after switching the camera off and switching on again.

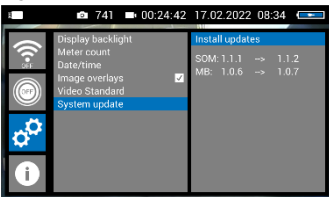
After every change of the video standard (PAL / NTSC), the camera must be restarted.

- Send the camera to an authorized Wöhler service center if a firmware update is to be performed.

12 Transmission of images via WLAN

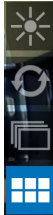

Fig. 40: System menu selected



Fig. 41: WLAN icon

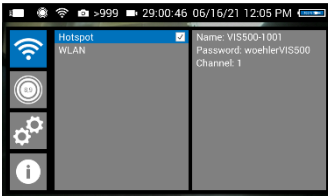

Fig. 42: Selection of WLAN operating mode

- Go to the system menu, see chapter 11.4.

- Navigate to the WLAN icon to activate the WLAN function of the camera system.

This function allows you to view live images on the VIS 500 monitor while a colleague, e.g. at the other end of the pipe, watches the videos live on his mobile device.

There are two possibilities to transmit images and videos to a mobile device:

1. Hotspot: Wöhler VIS 500 builds own WLAN network
2. WLAN: Connect the Wöhler VIS 500 and your mobile device (Android or iOS) to a stationary WLAN network.



NOTE!

If the WLAN function on the camera is active, it will be also active after restarting the camera.

12.1 Hotspot: VIS 500 WLAN network

The Wöhler VIS 500 builds its own WLAN network if you select the WLAN mode “Hotspot“. It is possible to transmit image files to a mobile device.

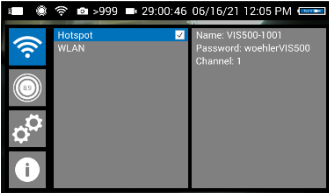

Fig. 43: Selection „Camera WLAN“

- Select **Hotspot > Start Hotspot**.
- The camera WLAN is active now. The WLAN icon is displayed in the header.

The submenu displays the network name of the Wöhler VIS 500, the password needed for the connection to the mobile device and the WLAN channel.

The **Networkname** is created as follows:

VIS500-serial number of the camera.

The preset **Password** is

woehlerVIS500

12.1.1 Change password and networkname

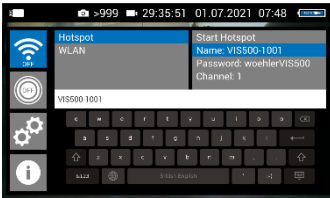

Fig. 44: Changing the password



Fig. 45: Enter-key

It is possible to change the network name and the password if necessary. When changing the network name, you could, for example, use your own company name as the network name.

- To change, navigate to the password or network name and confirm with the right arrow or **confirmation key**. A keyboard will appear on screen.
- Use the control pad to move to the character you want to select and confirm with the right arrow or the **confirmation key**.
- Save your entry with the Enter key on the keyboard.



NOTE!

If you save your changes or switch off the camera even though the password is too short or no character is entered for the network name, the password or network name will be reset to the last valid password.

- Please note the following restrictions on the network name and password:

Networkname

Network name:

The input field must not be empty.

The network name must not be longer than 32 characters.

Password

Password:

Valid length: 8 characters - 64 characters .



NOTE!

It is not possible to enter more than 64 characters. If your password has less than 8 characters it will be marked in red.

Permissible characters in each case:

Uppercase and lowercase letters from a to z.

Digits 0 to 9

The following special characters (network name):

_ - ! # \$ % & ' () + , . / : ; < = > ? @ ^ ` { | } ~

The following special characters (password):

_ - ! " # \$ % & ' () * + , . / : ; < = > ? @ [] ^ ` { | } ~

All other characters (letters, special characters, etc.) are not permitted.



NOTE!

Invalid characters cannot be typed during password entry. If the user tries to type an invalid character, nothing happens.

12.1.2 Select WLAN channel if necessary

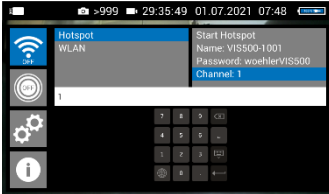

Fig. 46: Selecting a channel



Fig. 47: Enter key



Fig. 48: WLAN icon in the icon ribbon

If necessary, it is possible to select the WLAN channel. 13 WLAN channels can be selected
Default setting: channel 1



NOTE!

Normally it is not necessary to select another WLAN channel.

- If you want to change the channel, select channel and confirm with the confirmation key. A number field will open. A number entry from 1-13 is possible here.
- Use the control pad to move to the corresponding number and confirm with the confirmation key.
- Save your entry with the Enter key on the number field.

The WLAN icon is displayed in the icon ribbon of the display until the WLAN function is deactivated.

12.1.3 Establishing a connection to a mobile device

- To establish a connection between the camera and the mobile device, proceed as follows.
- Access the WLAN settings of your mobile device.
- Select the network **VIS500_[serial number, 4 digits] or the network name that you have chosen**
- Enter the password. The password is **woehlerVIS500 or the password that you have chosen**. Note the upper and lower case letters.

**NOTE!**

As long as your mobile device is connected to the VIS500 network, you will not be able to connect it to the Internet. Therefore, the warning message "Internet not available" appears.

- Wait until the Wöhler VIS 500 establishes contact with your mobile device.

You now have the possibility to view the live video in the Wöhler Videoinspection App on your mobile device.

12.2 WLAN: Using an existing WLAN network

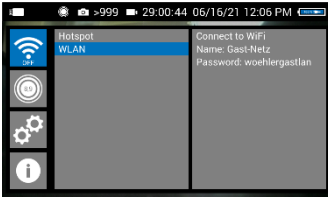

Fig. 49: Establishing the connection via an existing WLAN network

In the “WLAN” mode, you dial into an existing network both with the Wöhler VIS 500 and with a mobile device or a WLAN-capable PC or Laptop. This way, live image transmission from the camera to the mobile device/laptop is even possible over a certain distance. This possibility can be interesting in industrial plants, for example.



NOTE!

If the Wöhler VIS 500 was connected to an existing network via the client mode, it will connect to this network again after a restart. If the camera is not within range of this network when rebooting, the WLAN is deactivated on the camera.

- Select **WLAN**

All available networks will appear in the camera display.

- Select the network.
- Enter the password of your network.
- Confirm with OK.



NOTE

The password will always be saved so that you do not have to enter it the next time you log on to the same network.

- Select „Connect to WLAN“ and confirm.

The camera will now connect to the WiFi-network.



Fig. 50: WLAN-Icon in THE headline

Connection to a mobile device or laptop

- After a successful connection, the WLAN icon will appear in the icon ribbon in the top bar of the display.
- Proceed as follows to establish the connection between the camera and the mobile device or laptop.
- Open the WLAN settings of your mobile device.

- Select the same network that you dialed into with the camera.
- Enter the password of your network.

You now have the possibility to view the live video in the Wöhler Videoinspection App on your mobile device.

13 Faults

13.1 Reset



Fig. 51: Reset hole indicated by an arrow

It is possible to rectify certain malfunctions by initiating a reset operation. The reset hole is located on the rear of the monitor next to the camera connection port, see Figure opposite.

- Reset 1: Insert a thin object, for example a straightened paper clip, into the reset hole and press for 2-3 seconds. All keys should then light up.
- Reset 2: If all keys do not light up after 2-3 seconds, insert a thin object into the reset hole and press for approx. 15 seconds. All keys should then light up.



NOTE!

Depending on the type of reset operation the reset time (until all keys light up) is between 2 and 15 seconds. The reset operation is successful when all keys light up.

13.2 Possible malfunctions

Fault description	Possible cause	Remedy
Image and video keys flash rapidly when the device is turned on.	Rechargeable battery is flat.	Recharge the battery
Monitor and camera head switched on. No image or stuttering image replay.	Rod is broken.	Return the device for repair.
Camera stops video recording	No video signal, e.g. due to a broken rod	If it occurs repeatedly, return the unit for repair.
Blurred images	Plastic dome scratched.	Replace the plastic dome; glass dome optional.
Camera system dead	Rechargeable battery is flat.	Recharge the battery.
	Device is faulty.	Return the device for repair.

14 Maintenance

14.1 Information on maintenance

Proper operation of the Service Camera requires regular maintenance. The following maintenance works can be done by the user himself.

14.2 Replacing the dome of the camera head



Fig. 52: Fitting the camera dome



NOTE!

The camera head is supplied protected by a plastic dome, which can be replaced if necessary, for example, if it becomes scratched. It is optional to fit this camera head with a glass dome for use in dry working environments.

Before replacing the dome, the thread of the new dome must be sparingly greased with silicone grease. When replacing the dome, make sure that no grease gets into the camera head and especially its mechanical components.

When fitting the replacement dome, make sure you engage all of the thread to ensure it is properly tightened. Otherwise, it cannot be guaranteed that the camera head is properly sealed, and malfunctions can occur as a result of water and dirt ingress.

14.3 Camera head

- Only use soft, damp cloth to clean the lens. Never use any cleanser.

14.4 Monitor

- Clean the monitor using a soft cloth.

14.5 Cleaning the viper and the rod

The viper with the rod is placed in the lower shell of the case. It is possible to take it out and clean it with water. In this case the camera head can remain fixed to the camera rod. If you remove the camera head from the rod, you must seal the rod end with a plug before cleaning.

! ATTENTION!

Never use a high-pressure cleaner for hosing down!

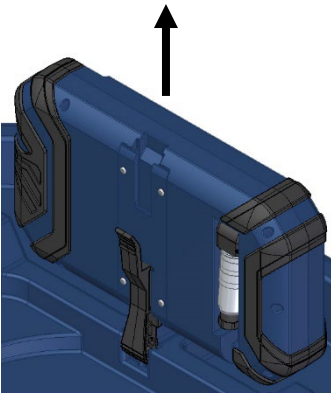

Fig. 53: Monitor in an upright position

- To do so proceed as follows:
- First open the upper shell of the case.
- Place the monitor in an upright position and pull it from the support.
- Unscrew the union nut of the monitor cable and remove the monitor cable from the monitor.
- Store the monitor so that it cannot become wet when you are cleaning the viper.
- Push the monitor support back into the case.



Fig. 54: Upper shell of the case with monitor cable and without monitor



Fig. 55: Lower shell opened

- Open the black locks of the lower shell.
- Pull the camera cable through the opening of the upper shell.
- Remove the viper from the case.

Cleaning the viper and the rod



Fig. 56: Viper removed from the case, monitor plug covered by a lid

! CAUTION!

Take care that no water comes into the plug connections of the rod.

- If the camera head is not connected to the rod during cleaning, secure the rod end against the ingress of water, e.g. with a foil or plug.

☞ NOTE!

The waterproof camera head can remain attached to the camera rod while cleaning. In this case take care that the connection is tight.



Fig. 57: Cleaning the viper and the rod

Cleaning the lower shell of the case



Fig. 58: Lower shell of the case

- Clean the viper and the rod with water.

- Flush the lower shell of the case with water.
- Dry the case with a cloth.
- To avoid humidity in the case, allow the viper and the rod to dry.

- After that mount the case in reverse order.
- Place the reel in the protrusion of the lower shell.

Assembly of the case

Fig. 59: Guide the monitor cable into the upper shell and carefully pull it taut.

- Feed the monitor cable completely through the hole of the upper shell.
- Pull the camera cable through the opening to the upper shell of the case.
- Guide the monitor cable completely through the hole in the upper shell. To do so, pull the monitor cable tightly through the opening.
- Then close the lower shell of the case.



Fig. 60: Wrong: Camera cable not pulled tight

! **CAUTION!**

If the upper shell of the case is closed even though the monitor cable is not completely pulled into the top shell of the case, the cable may break.



Fig. 61: Monitor cable in the upper shell

- Wind up the monitor cable in the upper shell and connect the monitor cable to the monitor.
- Put the monitor back into the case in its transport position.
- Close the case lid.



Fig. 62: Rod with camera head

- Guide the end of the rod with the camera head through the opening and after that push the camera head into the case.

15 Guide accessories

This section contains some recommendations based on our experience about the selection of guide accessories for the inspection in tubes and ducts.

As all pipes and chimney systems are different, the user has to decide about the guide accessory in every single case. For the selection of the correct tool it is important to consider that the guide accessory has to facilitate the introduction and the extraction of the camera head, as well as an adequate guidance. The danger of jamming or getting stuck in the tube has to be avoided.

Pipe Ø	Camera Head Ø 26 mm	Camera Head Ø 40 mm
40	Without accessories	Inspection not possible
50	3827	Inspection not possible
60	3634, 3827, 3847	2641, 3682
70	3634, 3827, 3847, 8818	2641, 3682, 8818
100	3634, 3827, 3847, 8818, 3850, 3857	2641, 3682, 8818, 3850, 3857
125	3634, 3827, 3847, 8818, 3850, 3857, 3681	2641, 3682, 8818, 3850, 3857, 3681
150	Every accessory possible	Every accessory possible

Table: Appropriated accessories (article numbers)

16 Warranty and Service

16.1 Warranty

Each Wöhler VIS 500 Service Camera will be tested in all functions and will leave our factory only after extensive quality control testing.

If used properly, the warranty period for the Wöhler VIS 500 will be 12 month from the date of sale. Not covered by the warranty is the plastic dome.

Service by non authorized personnel or making modifications to the analyzer voids any warranty.

16.2 Service

Excellent SERVICE is very important to us. Therefore, of course, we are readily available to assist you after the warranty period ends.

- Send us the Camera and we will repair it and return it to you with our package service.
- Immediate help is provided by our technical staff over the telephone.

17 Declaration of Conformity

The manufacturer:

Wöhler Technik GmbH

Wöhler-Platz 1, D-33181 Bad Wünnenberg

hereby declares that the following product:

Product: Inspection Camera

Model: Wöhler VIS 500

complies with the safety requirements set out in the directives of the European parliament and council on the approximation of laws of the Member States relating to electromagnetic compatibility (2014/53/EU).

The following standards were used to access the products in terms of electromagnetic compatibility.

The following standards were used to access the products in terms of electromagnetic compatibility:

EN 61326-1:2013 / IEC 61326-1:2012

ETSI EN 301 489-1 V2.2.3 (2019-11)

ETSI EN 301 489-17 V3.2.4 (2020-09)

ETSI EN 300 328 V2.2.2 (2019-07)

ETSI EN 300 330 V2.1.1 (2017-02)

EN 62311 (2020)

EN 62368-1 :2014+ AC:2015 + A11:2017

IEC 62368-1 :2014 (Ed. 2) + Cor.:2015

This device complies with Industry Canada licence-exempt RSS standard(s) and part 15 of the FCC Rules. Operation is subject to the following two conditions: (1) this device may not cause interference, and (2) this device must accept any interference, including interference that may cause undesired operation of the device.

Note: This equipment has been tested and found to comply with the limits for a Class A digital device, pursuant to part 15 of the FCC Rules. These limits are designed to provide reasonable protection against harmful interference when the equipment is operated in a

Declaration of Conformity

commercial environment. This equipment generates, uses, and can radiate radio frequency energy and, if not installed and used in accordance with the instruction manual, may cause harmful interference to radio communications. Operation of this equipment in a residential area is likely to cause harmful interference in which case the user will be required to correct the interference at his own expense.

Changes or modifications not expressly approved by the party responsible for compliance could void the user's authority to operate the equipment.

RF Exposure Information

The device complies with the FCC and ISED radiation exposure limits for an uncontrolled environment.

Déclaration d'exposition aux radiations



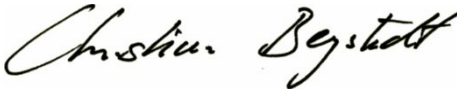

Cet équipement est conforme aux limites d'exposition aux rayonnements ISED établies pour un environnement non contrôlé.

CAN ICES-003(A) / NMB-003(A)

Bad Wünnenberg, 15.11.2023

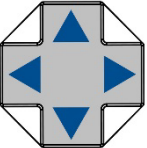

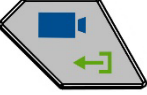
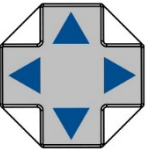
Christian Beyerstedt, Documentation Representative

18 Short Manual	
18.1 On/Off - Key Menu-Key 	<ul style="list-style-type: none"> To switch the camera on, press the on/off key for 1 s. To switch it off, press the on/off key for 2 s. Press the menu key to show or hide the menu.
18.2 Hidden menu 	<ul style="list-style-type: none"> Control the camera head with the control pad.
Pan 180°	<ul style="list-style-type: none"> Pan the camera head with the up/down arrows.
Rotate 360°	<ul style="list-style-type: none"> Rotate the camera head with the left/right arrows.
	<ul style="list-style-type: none"> Press the image key to take a picture.
	<ul style="list-style-type: none"> Press the video key to start a video recording. Press the video key again to stop the video recording.
18.3 Menu on screen	
	<ul style="list-style-type: none"> Navigate through the menu with the control pad.
	<ul style="list-style-type: none"> Confirm your selection with the confirmation key or with the right arrow.

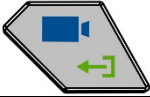

- To exit a submenu, press the **back key** or the left arrow.

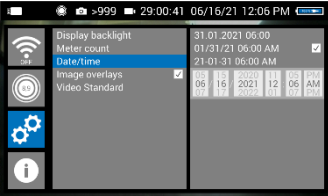

- The currently selected menu level is highlighted in blue.